

Surname	Centre Number	Candidate Number
First name(s)		0



GCSE

3300U60-1



WEDNESDAY, 13 NOVEMBER 2019 – MORNING

**MATHEMATICS
UNIT 2: CALCULATOR-ALLOWED
HIGHER TIER**

1 hour 45 minutes

ADDITIONAL MATERIALS

A calculator will be required for this examination.
A ruler, a protractor and a pair of compasses may be required.

INSTRUCTIONS TO CANDIDATES

Use black ink or black ball-point pen. Do not use gel pen or correction fluid.
You may use a pencil for graphs and diagrams only.
Write your name, centre number and candidate number in the spaces at the top of this page.
Answer **all** the questions in the spaces provided.
If you run out of space, use the additional page at the back of the booklet. Question numbers must be given for all work written on the additional page.
Take π as 3.14 or use the π button on your calculator.

INFORMATION FOR CANDIDATES

You should give details of your method of solution when appropriate.
Unless stated, diagrams are not drawn to scale.
Scale drawing solutions will not be acceptable where you are asked to calculate.
The number of marks is given in brackets at the end of each question or part-question.
In question 2(b), the assessment will take into account the quality of your linguistic and mathematical organisation, communication and accuracy in writing.

For Examiner's use only		
Question	Maximum Mark	Mark Awarded
1.	4	
2.	9	
3.	6	
4.	3	
5.	3	
6.	4	
7.	6	
8.	1	
9.	6	
10.	3	
11.	9	
12.	3	
13.	3	
14.	5	
15.	5	
16.	3	
17.	7	
Total	80	

3300U601
01



NOV193300U60101

Formula List - Higher Tier

Area of trapezium = $\frac{1}{2}(a + b)h$

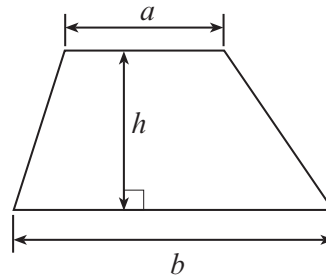

Volume of prism = area of cross-section \times length

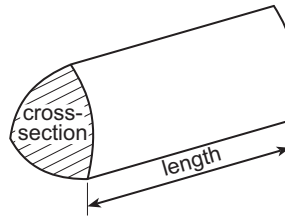

Volume of sphere = $\frac{4}{3}\pi r^3$

Surface area of sphere = $4\pi r^2$

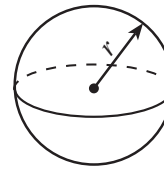

Volume of cone = $\frac{1}{3}\pi r^2 h$

Curved surface area of cone = $\pi r l$

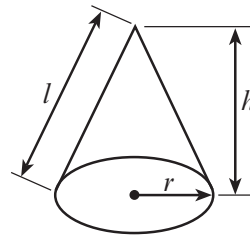

In any triangle ABC

Sine rule $\frac{a}{\sin A} = \frac{b}{\sin B} = \frac{c}{\sin C}$

Cosine rule $a^2 = b^2 + c^2 - 2bc \cos A$

Area of triangle = $\frac{1}{2} ab \sin C$

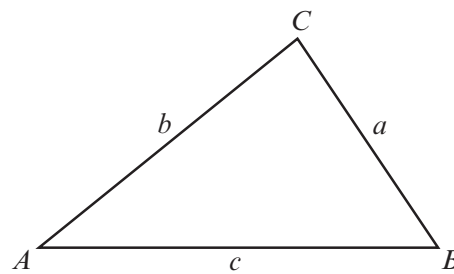

The Quadratic Equation

The solutions of $ax^2 + bx + c = 0$ where $a \neq 0$ are given by $x = \frac{-b \pm \sqrt{(b^2 - 4ac)}}{2a}$

Annual Equivalent Rate (AER)

AER, as a decimal, is calculated using the formula $\left(1 + \frac{i}{n}\right)^n - 1$, where i is the nominal interest rate per annum as a decimal and n is the number of compounding periods per annum.



2. (a) A biased coin is thrown 100 times.
The number of heads thrown is recorded after 20 throws, 40 throws, 60 throws, 80 throws and 100 throws.

Some of the results are recorded in the relative frequency table below.

Complete the table.

[2]

Number of throws	20	40	60	80	100
Number of heads	11	18	24	30	
Relative frequency	0.55	0.45		0.375	0.37

.....

.....

.....

.....



3. The table below shows some of the values of $y = x^2 - 2x - 4$ for values of x from -3 to 4 .

x	-3	-2	-1	0	1	2	3	4
$y = x^2 - 2x - 4$	11	4	-1	-4		-4	-1	4

- (a) Complete the table by finding the value of y when $x = 1$. [1]

.....

.....

- (b) On the graph paper opposite, draw the graph of $y = x^2 - 2x - 4$ for values of x from -3 to 4 . [2]

- (c) (i) Draw the line $y + x = 4$ on the graph paper. [2]

.....

.....

.....

- (ii) Write down the values of x where the line $y + x = 4$ cuts the curve $y = x^2 - 2x - 4$. [1]

Values of x are and



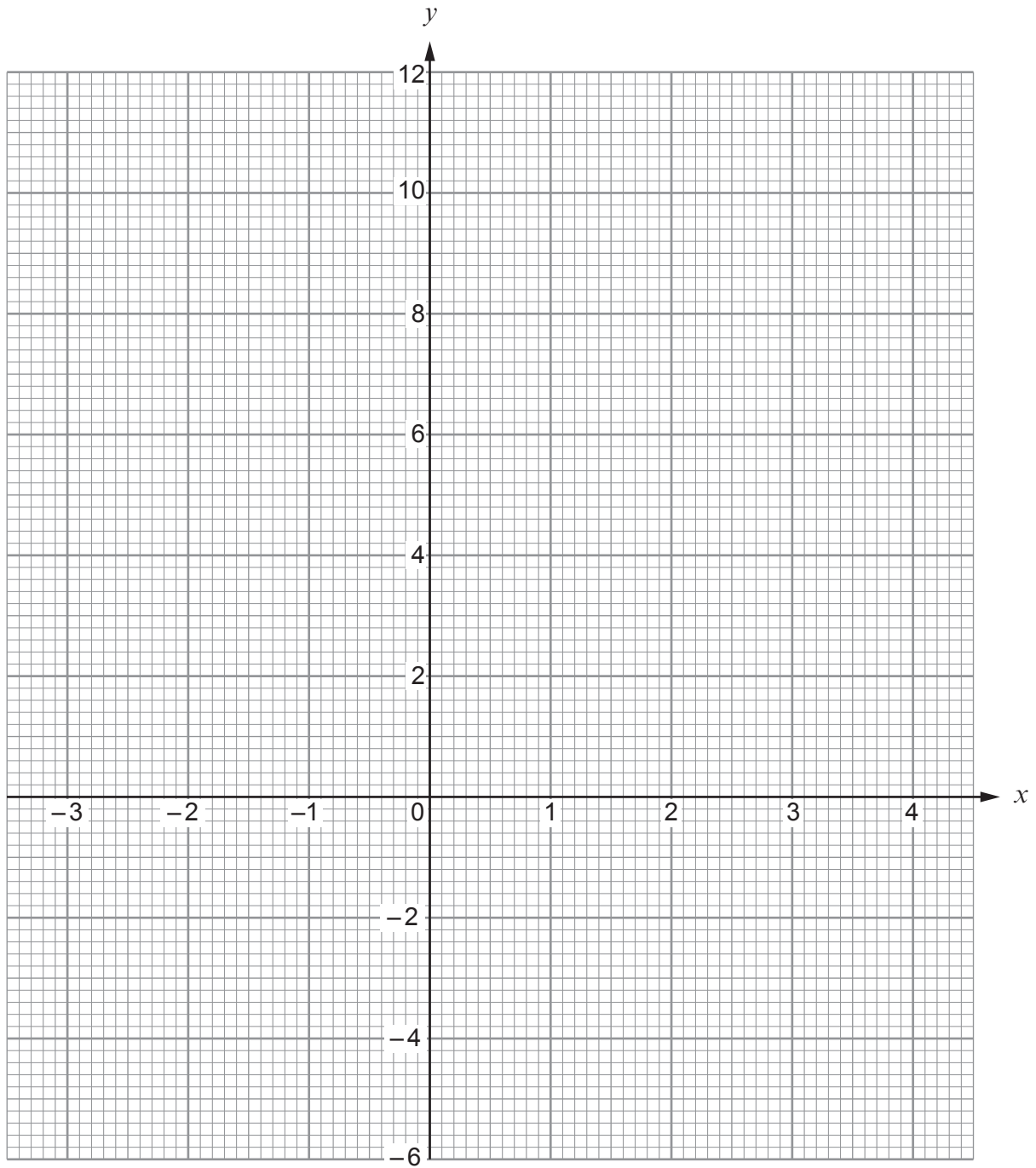

3300U601
07



4. Sian thinks of a number.
Its value is increased by 25%.

Express the original number as a percentage of the increased number.

[3]

.....

.....

.....

.....

.....

.....

.....

.....

.....

.....

5. Calculate the length of the side MN in the triangle LMN shown below.

[3]

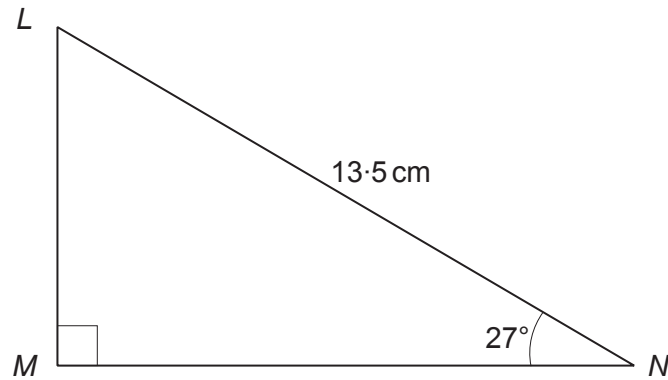

Diagram not drawn to scale

.....

.....

.....

.....

.....

.....

.....

.....

.....

.....



7. A solid object is made by drilling a cylindrical hole of radius 4 cm through a cuboid measuring 20 cm by 15 cm by 10 cm as shown below.

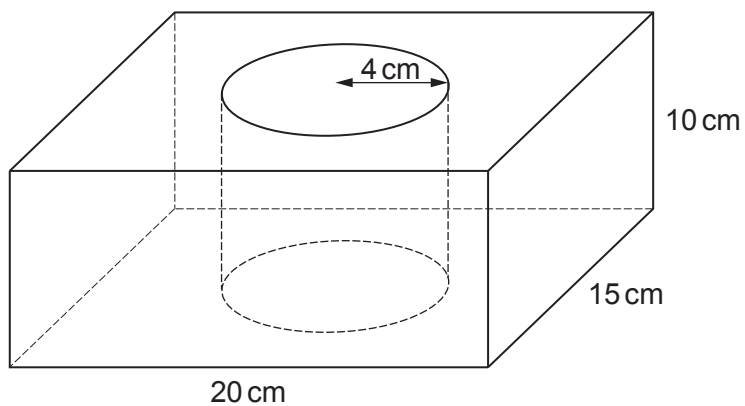

Diagram not drawn to scale

- (a) Calculate the volume of the object.
Give your answer in cm^3 .

[3]

.....

.....

.....

.....

.....

.....

.....

Volume = cm^3



- (b) The object is made from a material which has a density of 2.4 g/cm^3 .
Calculate the mass of the object.
Give your answer in kg, correct to the nearest kg. [3]

.....

.....

.....

.....

.....

.....

.....

.....

.....

Mass = kg

8. The equation of a straight line is $y = 8x - 5$.
What is the gradient of the line?

Circle the correct answer. [1]

$\frac{1}{8}$

-5

8

5

1



10. Simplify, and then factorise, the following expression.

[3]

$$k(9k - 1) + k - 25n^2$$

.....

.....

.....

.....

.....

.....

.....

.....

.....

.....

.....

.....

.....

.....

.....



11. (a) The area of the trapezium $ABCD$ is 25 cm^2 .

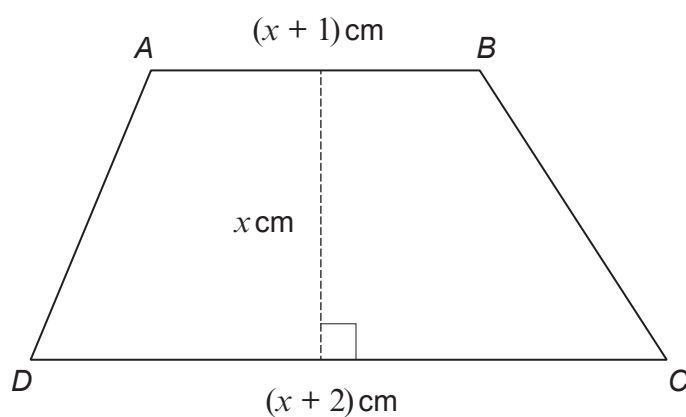

Diagram not drawn to scale

- (i) Show that $2x^2 + 3x - 50 = 0$. [3]

.....

.....

.....

.....

.....

.....

.....

.....

- (ii) Solve the equation $2x^2 + 3x - 50 = 0$ to calculate the lengths AB and DC .
Give your answers correct to 1 decimal place. [4]

.....

.....

.....

.....

.....

.....

.....

.....

.....

Length of $AB = \dots\dots\dots$ cm

Length of $DC = \dots\dots\dots$ cm



- (b) A rhombus has an area of 36.8 cm^2 .
The rhombus is enlarged by a scale factor of 7.
Calculate the area of the enlarged rhombus.

[2]

.....

.....

.....

.....

.....

.....

.....

.....

.....

.....

.....

.....

.....

.....

.....

.....



12. The diagram shows a sector of a circle with centre O and radius 7 cm.
Calculate the perimeter of the sector OAB .

[3]

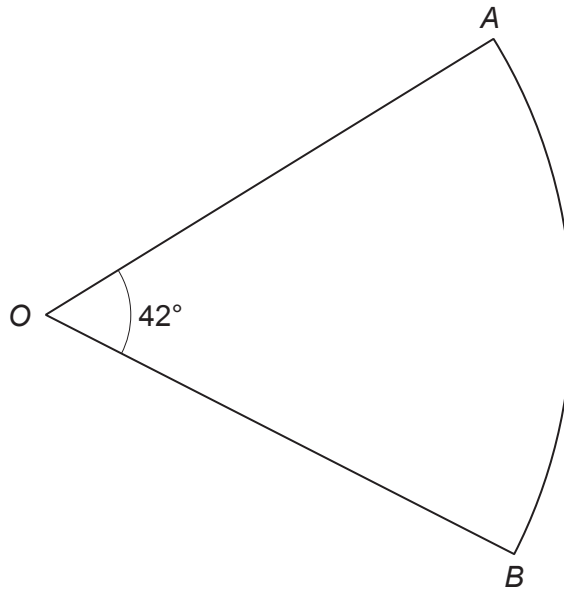

Diagram not drawn to scale

.....

.....

.....

.....

.....

.....

.....

.....

.....

.....

.....



13. Describe fully a **single** transformation that transforms shape A onto shape B.

[3]

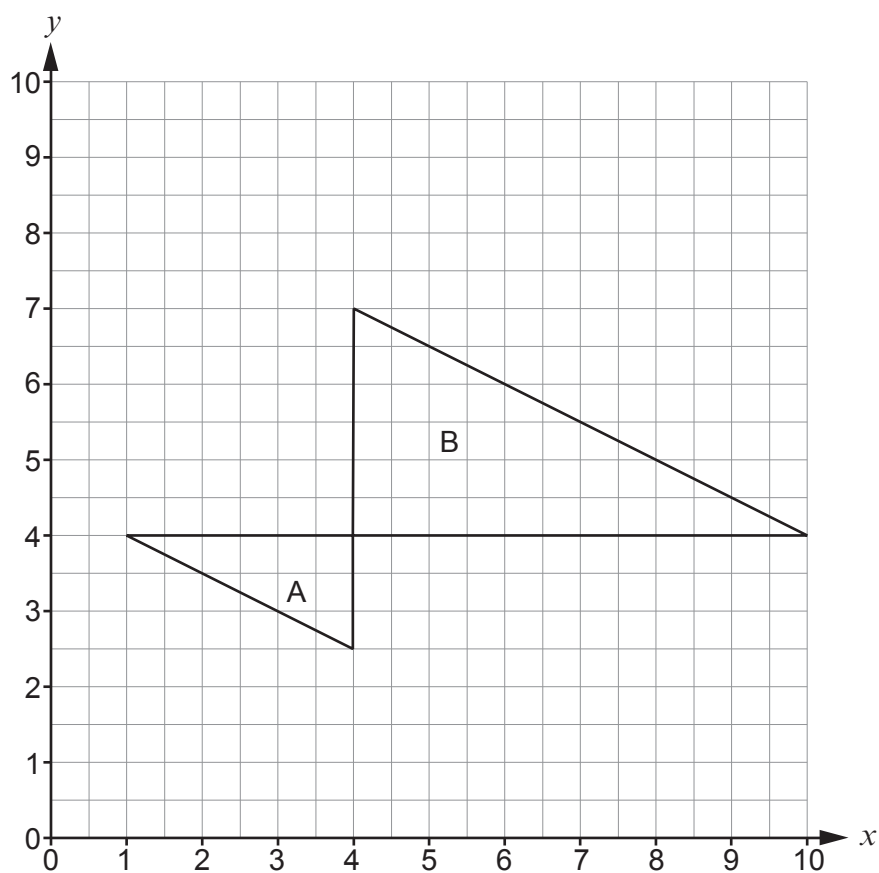

.....

.....

.....

.....

.....

.....

.....

.....

.....

.....



14. The following twelve cards are placed in a box.

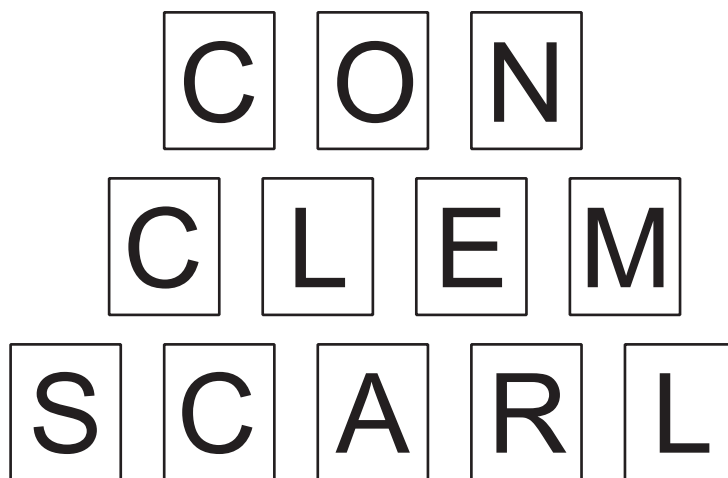

Three cards are chosen at random from the box at the same time.

(a) Calculate the probability that the three cards drawn are all the letter 'C'. [2]

.....

.....

.....

.....

.....

.....

(b) The letters A, E and O are vowels. All the other letters on these cards are consonants.

Calculate the probability that the three cards drawn include at least one consonant and at least one vowel. [3]

.....

.....

.....

.....

.....

.....

.....

.....

.....

.....



16. The following graph represents the curve $y = f(x)$.

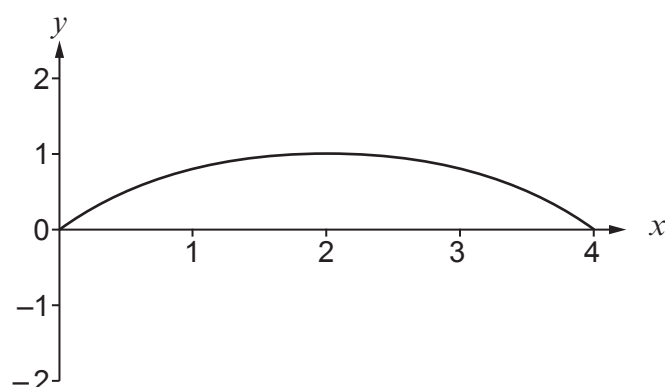

There are 9 equations and 4 graphs of different transformations of $y = f(x)$ shown below. Choose the equation which describes each transformation of $y = f(x)$. Write it in the box provided.

One has been completed for you.

[3]

Equations

$$y = f(2x)$$

$$y = f(x - 1)$$

$$y = f(x) - 1$$

$$y = -f(x)$$

$$y = f(x) + 1$$

$$y = f(-x)$$

$$y = \frac{1}{2}f(x)$$

$$y = 2f(x)$$

$$y = -2f(x)$$

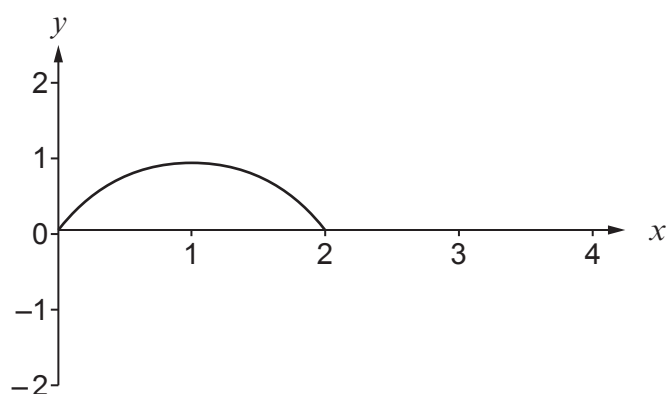

Equation: $y = f(2x)$



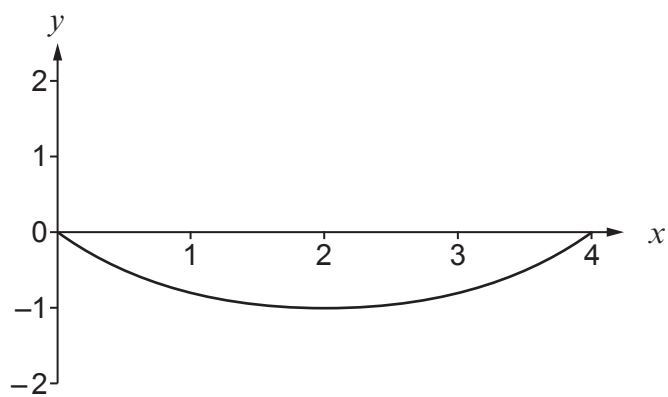

Equation:

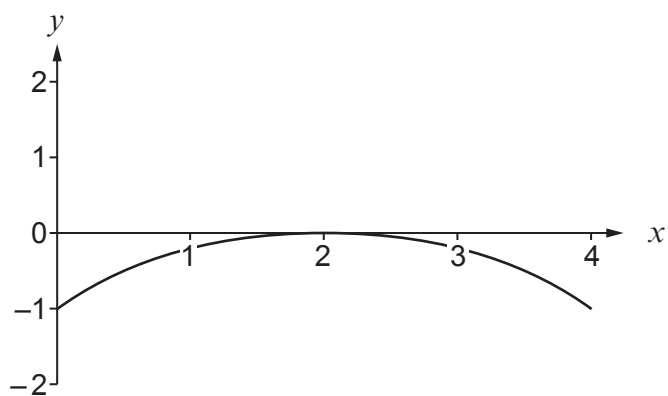

Equation:

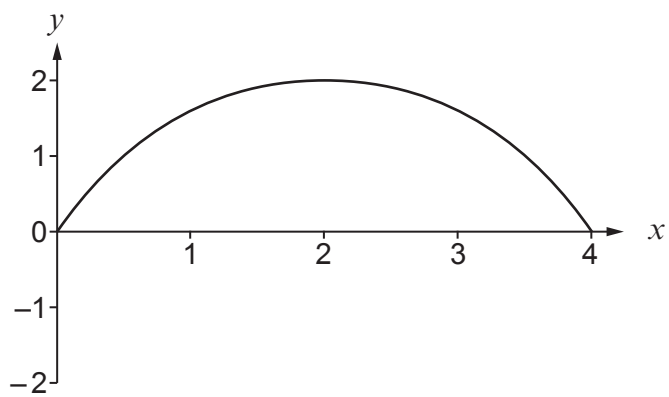

Equation:



BLANK PAGE

**PLEASE DO NOT WRITE
ON THIS PAGE**

